

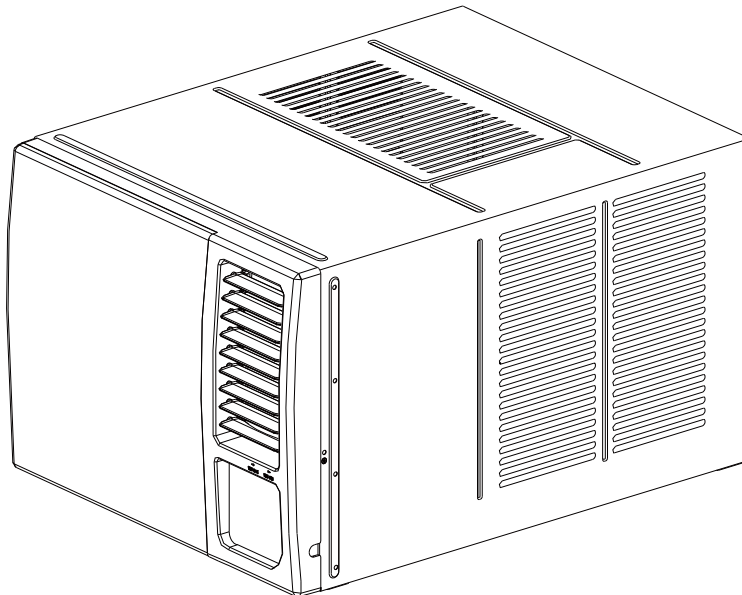

**WINDOW-TYPE ROOM AIR CONDITIONER**

---

# Owner's Manual & Installation Manual



**IMPORTANT NOTE:**

Read this manual carefully before installing or operating your new air conditioning unit. Make sure to save this manual for future reference.

Please check the applicable models, technical data from the nameplate pasted on the unit.

# Table of Contents

Safety Precautions .....	03
Unit Parts Identification .....	09
Operation Instructions.....	10
Care and Maintenance.....	12
Water Drainage .....	12
Installation Instructions .....	13
Troubleshooting.....	15
Specifications .....	16

## European Disposal Guidelines

This marking shown on the product or its literature, indicates that waste electrical and electrical equipment should not be mixed with general household waste.



### Correct Disposal of This Product (Waste Electrical & Electronic Equipment)

This appliance contains refrigerant and other potentially hazardous materials. When disposing of this appliance, the law requires special collection and treatment. **Do not** dispose of this product as household waste or unsorted municipal waste.

When disposing of this appliance, you have the following options:

- Dispose of the appliance at designated municipal electronic waste collection facility.
- When buying a new appliance, the retailer will take back the old appliance free of charge.
- The manufacturer will take back the old appliance free of charge.
- Sell the appliance to certified scrap metal dealers.

### Special notice

Disposing of this appliance in the forest or other natural surroundings endangers your health and is bad for the environment. Hazardous substances may leak into the ground water and enter the food chain.

# Safety Precautions

## Read Safety Precautions Before Operation and Installation

**Incorrect installation due to ignoring instructions can cause serious damage or injury.**

The seriousness of potential damage or injuries is classified as either a **WARNING** or **CAUTION**.



### WARNING

This symbol indicates the possibility of personnel injury or loss of life.



### CAUTION

This symbol indicates the possibility of property damage or serious consequences.



### WARNING

This appliance can be used by children aged from 8 years and above and persons with reduced physical, sensory or mental capabilities or lack of experience and knowledge if they have been given supervision or instruction concerning use of the appliance in a safe way and understand the hazards involved. Children shall not play with the appliance. Cleaning and user maintenance shall not be made by children without supervision(EN Standard requirements).

This appliance is not intended for use by persons(including children) with reduced physical, sensory or mental capabilities, or lack of experience and knowledge, unless they have been given supervision or instruction concerning use of the appliance by a person responsible for their safety. Children should be supervised to ensure that they do not play with the appliance.



### WARNINGS FOR PRODUCT USE

- If an abnormal situation arises (like a burning smell), immediately turn off the unit and disconnect the power. Call your dealer for instructions to avoid electric shock, fire or injury.
- **Do not** insert fingers, rods or other objects into the air inlet or outlet. This may cause injury, since the fan may be rotating at high speeds.
- **Do not** use flammable sprays such as hair spray, lacquer or paint near the unit. This may cause fire or combustion.
- **Do not** operate the air conditioner in places near or around combustible gases. Emitted gas may collect around the unit and cause explosion.
- **Do not** operate your air conditioner in a wet room such as a bathroom or laundry room. Too much exposure to water can cause electrical components to short circuit.
- **Do not** expose your body directly to cool air for a prolonged period of time.
- **Do not** allow children to play with the air conditioner. Children must be supervised around the unit at all times.
- If the air conditioner is used together with burners or other heating devices, thoroughly ventilate the room to avoid oxygen deficiency.
- In certain functional environments, such as kitchens, server rooms, etc., the use of specially designed air-conditioning units is highly recommended.
- Unplug the unit or disconnect the power supply to the unit if strange sounds, smell, or smoke comes from it.
- To further optimize the performance of your unit, keep doors and windows closed during operation.
- Pay attention when unpacking and installing. Sharp edges could cause injury.

### CLEANING AND MAINTENANCE WARNINGS

- Turn off the device and disconnect the power before cleaning. Failure to do so can cause electrical shock.
- **Do not** clean the air conditioner with excessive amounts of water.
- **Do not** clean the air conditioner with combustible cleaning agents. Combustible cleaning agents can cause fire or deformation.



### CAUTION

- Turn off the air conditioner and disconnect the power if you are not going to use it for a long time.
- Turn off and unplug the unit during storms.
- Make sure that water condensation can drain unhindered from the unit.
- **Do not** operate the air conditioner with wet hands. This may cause electric shock.
- **Do not** use device for any other purpose than its intended use.
- **Do not** climb onto or place objects on top of the outdoor unit.
- **Do not** allow the air conditioner to operate for long periods of time with doors or windows open, or if the humidity is very high.



## ELECTRICAL WARNINGS

- Only use the specified power cord. If the power cord is damaged, it must be replaced by the manufacturer, its service agent or similarly qualified persons in order to avoid a hazard.
- Keep power plug clean. Remove any dust or grime that accumulates on or around the plug. Dirty plugs can cause fire or electric shock.
- **Do not** pull power cord to unplug unit. Hold the plug firmly and pull it from the outlet. Pulling directly on the cord can damage it, which can lead to fire or electric shock.  
**Do not** modify the length of the power supply cord or use an extension cord to power the unit.
- **Do not** share the electrical outlet with other appliances. Improper or insufficient power supply can cause fire or electrical shock. Always install circuit breaker and a dedicated power circuit.
- **Do not** use the socket if it is loose or damaged.
- **Do not** place heavy object on the power cord and ensure that the cord is not compressed.  
There is danger of fire or electric shock.
- If water enters the unit, turn the unit off at the power outlet and switch off the circuit breaker.  
Isolate supply by taking the power-plug out or disconnect the power supply to the unit, contact a qualified service technician.
- The product must be properly grounded at the time of installation, or electrical shock may occur.
- For all electrical work, follow all local and national wiring standards, regulations, and the Electrical Connection Diagram located on the top panel of the unit.
- If connecting power to fixed wiring, an all-pole disconnection device which has at least 3mm clearances in all poles, and have a leakage current that may exceed 10mA, the residual current device(RCD) having a rated residual operating current not exceeding 30mA, and disconnection must be incorporated in the fixed wiring in accordance with the wiring rules.
- This unit is earthed through the power cord, make sure that the unit is correctly grounded. The wall outlet(Air-break switch) should be provided with reliable earth wire.
- The unit should be provided with an individual circuit and the circuit breaker/fuse rating should be the same as that of the power cord and wall outlet. Power cord conductors are distinguished according to the color as shown in Wiring Diagram located on the top of the machine.

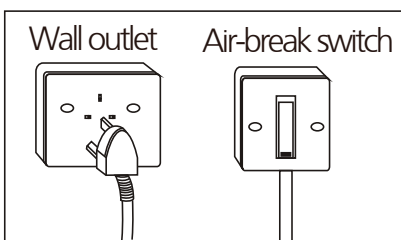

## TAKE NOTE OF FUSE SPECIFICATIONS

The air conditioner's circuit board (PCB) is designed with a fuse to provide overcurrent protection. The specifications of the fuse are printed on the circuit board, such as T3.15A/250V(or 350V), etc,



## WARNINGS FOR PRODUCT INSTALLATION

1. Installation must be performed by an authorized dealer or specialist. Defective installation can cause water leakage, electrical shock, or fire.
2. Installation must be performed according to the installation instructions. Improper installation can cause water leakage, electrical shock, or fire. (In North America, installation must be performed in accordance with the requirement of NEC and CEC by authorized personnel only.)
3. Contact an authorized service technician for repair or maintenance of this unit. This appliance shall be installed in accordance with national wiring regulations.
4. Only use the included accessories, parts, and specified parts for installation. Using non-standard parts can cause water leakage, electrical shock, fire, and can cause the unit to fail.
5. Install the unit in a firm location that can support the unit's weight. If the chosen location cannot support the unit's weight, or the installation is not done properly, the unit may drop and cause serious injury and damage.
6. Install drainage piping according to the instructions in this manual. Improper drainage may cause water damage to your home and property.
7. For units that have an auxiliary electric heater, do not install the unit within 1 meter (3 feet) of any combustible materials.
8. **Do not** install the unit in a location that may be exposed to combustible gas leaks. If combustible gas accumulates around the unit, it may cause fire.
9. **Do not** turn on the power until all work has been completed.
10. When moving or relocating the air conditioner, consult experienced service technicians for disconnection and reinstallation of the unit.
11. How to install the appliance to its support, please read the information for details in "Installation instructions" section.

## Note about Fluorinated Gasses

1. Fluorinated greenhouse gases are contained in hermetically sealed equipment. For specific information on the type, the amount and the CO<sub>2</sub> equivalent in tonnes of the fluorinated greenhouse gas (on some models), please refer to the relevant label on the unit itself.
2. Installation, service, maintenance and repair of this unit must be performed by a certified technician.
3. Product uninstallation and recycling must be performed by a certified technician.

## UV-C lamp (Applicable to the unit contains an UV-C lamp only)

This appliance contains a UV-C lamp. Read the maintenance instructions before opening the appliance.

1. Do not operate UV-C lamps outside of the appliance.
2. Appliances that are obviously damaged must not be operated.
3. Unintended use of the appliance or damage to the housing may result in the escape of dangerous UV-C radiation. UV-C radiation may, even in small doses, cause harm to the eyes and skin.
4. Before opening doors and access panels bearing the ULTRAVIOLET RADIATION hazard symbol for the conducting USER MAINTENANCE, it is recommended to disconnect the power.
5. The UV-C lamp can not be cleaned, repaired and replaced.
6. UV-C BARRIERS bearing the ULTRAVIOLET RADIATION hazard symbol should not be removed.

**⚠ WARNING** This appliance contains an UV emitter. Do not stare at the light source.



## WARNING for Using R32/R290 Refrigerant

- Do not use means to accelerate the defrosting process or to clean, other than those recommended by the manufacturer.
- The appliance shall be stored in a room without continuously operating ignition sources (for example: open flames, an operating gas appliance) and ignition sources (for example: an operating electric heater) close to the appliance. The appliance shall be stored in a room without continuously operating ignition sources (for example: open flames, an operating gas appliance or an operating electric heater).
- Do not pierce or burn.
- Be aware that the refrigerants may not contain an odour.
- Compliance with national gas regulations shall be observed.
- Keep ventilation openings clear of obstruction.
- The appliance shall be stored so as to prevent mechanical damage from occurring.
- A warning that the appliance shall be stored in a well-ventilated area where the room size corresponds to the room area as specified for operation.
- Any person who is involved with working on or breaking into a refrigerant circuit should hold a current valid certificate from an industry-accredited assessment authority, which authorises their competence to handle refrigerants safely in accordance with an industry recognised assessment specification.
- Servicing shall only be performed as recommended by the equipment manufacturer. Maintenance and repair requiring the assistance of other skilled personnel shall be carried out under the supervision of the person competent in the use of flammable refrigerants.
- Please follow the instruction carefully to handle, install, clear, service the air conditioner to avoid any damage or hazard. Flammable Refrigerant R32 is used within air conditioner. When maintaining or disposing the air conditioner, the refrigerant (R32 or R290) shall be recovered properly, shall not discharge to air directly.
- No any open fire or device like switch which may generate spark/arcing shall be around air conditioner to avoid causing ignition of the flammable refrigerant used. Please follow the instruction carefully to store or maintain the air conditioner to prevent mechanical damage from occurring.
- Flammable refrigerant is used in air conditioner. Please follow the instruction carefully to avoid any hazard.



Caution: Risk of fire/  
flammable materials







Warning: low burning  
velocity material  
(For R32 models apply to  
IEC60335-2-40:2018)



IMPORTANT NOTE: Read this manual  
carefully before installing or operating  
your new air conditioning unit.

## Explanation of symbols displayed on the unit(For the unit adopts R32/R290 Refrigerant only):

	<b>WARNING</b>	This symbol shows that this appliance used a flammable refrigerant. If the refrigerant is leaked and exposed to an external ignition source, there is a risk of fire.		<b>CAUTION</b>	This symbol shows that a service personnel should be handling this equipment with reference to the installation manual.
	<b>CAUTION</b>	This symbol shows that the operation manual should be read carefully.		<b>CAUTION</b>	This symbol shows that information is available such as the operating manual or installation manual.

### 1.Transport of equipment containing flammable refrigerants

See transport regulations

### 2.Marking of equipment using signs

See local regulations

### 3.Disposal of equipment using flammable refrigerants

See national regulations.

### 4.Storage of equipment/appliances

The storage of equipment should be in accordance with the manufacturer's instructions.

### 5.Storage of packed (unsold) equipment

Storage package protection should be constructed such that mechanical damage to the equipment inside the package will not cause a leak of the refrigerant charge.The maximum number of pieces of equipment permitted to be stored together will be determined by local regulations.

### 6.Information on servicing

#### 1)Checks to the area

Prior to beginning work on systems containing flammable refrigerants, safety checks are necessary to ensure that the risk of ignition is minimised. For repair to the refrigerating system, the following precautions shall be complied with prior to conducting work on the system.

#### 2)Work procedure

Work shall be undertaken under a controlled procedure so as to minimise the risk of a flammable gas or vapour being present while the work is being performed.

#### 3)General work area

All maintenance staff and others working in the local area shall be instructed on the nature of work being carried out. Work in confined spaces shall be avoided. The area around the workspace shall be sectioned off. Ensure that the conditions within the area have been made safe by control of flammable material.

#### 4)Checking for presence of refrigerant

The area shall be checked with an appropriate refrigerant detector prior to and during work, to ensure the technician is aware of potentially flammable atmospheres. Ensure that the leak detection equipment being used is suitable for use with flammable refrigerants, i.e. non-sparking, adequately sealed or intrinsically safe.

#### 5)Presence of fire extinguisher

If any hot work is to be conducted on the refrigeration equipment or any associated parts,appropriate fire extinguishing equipment shall be available to hand. Have a dry powder or CO<sub>2</sub> fire extinguisher adjacent to the charging area.

#### 6)No ignition sources

No person carrying out work in relation to a refrigeration system which involves exposing any pipe work that contains or has contained flammable refrigerant shall use any sources of ignition in such a manner that it may lead to the risk of fire or explosion. All possible ignition sources, including cigarette smoking, should be kept sufficiently far away from the site of installation, repairing, removing and disposal, during which flammable refrigerant can possibly be released to the surrounding space. Prior to work taking place, the area around the equipment is to be surveyed to make sure that there are no flammable hazards or ignition risks. No Smoking signs shall be displayed.

#### 7)Ventilated area

Ensure that the area is in the open or that it is adequately ventilated before breaking into the system or conducting any hot work. A degree of ventilation shall continue during the period that the work is carried out. The ventilation should safely disperse any released refrigerant and preferably expel it externally into the atmosphere.

#### 8)Checks to the refrigeration equipment

Where electrical components are being changed, they shall be fit for the purpose and to the correct specification. At all times the manufacturer's maintenance and service guidelines shall be followed. If in doubt consult the manufacturer's technical department for assistance. The following checks shall be applied to installations using flammable refrigerants:

The charge size is in accordance with the room size within which the refrigerant containing parts are installed;

The ventilation machinery and outlets are operating adequately and are not obstructed;

If an indirect refrigerating circuit is being used, the secondary circuit shall be checked for the presence of refrigerant;

Marking to the equipment continues to be visible and legible. Markings and signs that are illegible shall be corrected; Refrigeration pipe or components are installed in a position where they are unlikely to be exposed to any substance which may corrode refrigerant containing components, unless the components are constructed of materials which are inherently resistant to being corroded or are suitably protected against being so corroded.

#### 9) Checks to electrical devices

Repair and maintenance to electrical components shall include initial safety checks and component inspection procedures. If a fault exists that could compromise safety, then no electrical supply shall be connected to the circuit until it is satisfactorily dealt with. If the fault cannot be corrected immediately but it is necessary to continue operation, an adequate temporary solution shall be used. This shall be reported to the owner of the equipment so all parties are advised.

Initial safety checks shall include:

That capacitors are discharged: this shall be done in a safe manner to avoid possibility of sparking;

That there no live electrical components and wiring are exposed while charging, recovering or purging the system;

That there is continuity of earth bonding.

#### 7. Repairs to sealed components

1) During repairs to sealed components, all electrical supplies shall be disconnected from the equipment being worked upon prior to any removal of sealed covers, etc. If it is absolutely necessary to have an electrical supply to equipment during servicing, then a permanently operating form of leak detection shall be located at the most critical point to warn of a potentially hazardous situation.

2) Particular attention shall be paid to the following to ensure that by working on electrical components, the casing is not altered in such a way that the level of protection is affected. This shall include damage to cables, excessive number of connections, terminals not made to original specification, damage to seals, incorrect fitting of glands, etc.

Ensure that apparatus is mounted securely.

Ensure that seals or sealing materials have not degraded such that they no longer serve the purpose of preventing the ingress of flammable atmospheres. Replacement parts shall be in accordance with the manufacturer's specifications.

NOTE: The use of silicon sealant may inhibit the effectiveness of some types of leak detection equipment. Intrinsically safe components do not have to be isolated prior to working on them.

#### 8. Repair to intrinsically safe components

Do not apply any permanent inductive or capacitance loads to the circuit without ensuring that this will not exceed the permissible voltage and current permitted for the equipment in use. Intrinsically safe components are the only types that can be worked on while live in the presence of a flammable atmosphere. The test apparatus shall be at the correct rating. Replace components only with parts specified by the manufacturer. Other parts may result in the ignition of refrigerant in the atmosphere from a leak.

#### 9. Cabling

Check that cabling will not be subject to wear, corrosion, excessive pressure, vibration, sharp edges or any other adverse environmental effects. The check shall also take into account the effects of aging or continual vibration from sources such as compressors or fans.

#### 10. Detection of flammable refrigerants

Under no circumstances shall potential sources of ignition be used in the searching for or detection of refrigerant leaks.

A halide torch (or any other detector using a naked flame) shall not be used.

#### 11. Leak detection methods

The following leak detection methods are deemed acceptable for systems containing flammable refrigerants. Electronic leak detectors shall be used to detect flammable refrigerants, but the sensitivity may not be adequate, or may need recalibration. (Detection equipment shall be calibrated in a refrigerant-free area.) Ensure that the detector is not a potential source of ignition and is suitable for the refrigerant used. Leak detection equipment shall be set at a percentage of the LFL of the refrigerant and shall be calibrated to the refrigerant employed and the appropriate percentage of gas (25 % maximum) is confirmed. Leak detection fluids are suitable for use with most refrigerants but the use of detergents containing chlorine shall be avoided as the chlorine may react with the refrigerant and corrode the copper pipe-work. If a leak is suspected, all naked flames shall be removed/ extinguished. If a leakage of refrigerant is found which requires brazing, all of the refrigerant shall be recovered from the system, or isolated (by means of shut off valves) in a part of the system remote from the leak. Oxygen free nitrogen (OFN) shall then be purged through the system both before and during the brazing process.

#### 12. Removal and evacuation

When breaking into the refrigerant circuit to make repairs or for any other purpose conventional procedures shall be used. However, it is important that best practice is followed since flammability is a consideration. Opening of the refrigeration systems shall not be done by brazing. The following procedure shall be adhered to:

Remove refrigerant;

Purge the circuit with inert gas;

Evacuate;

Purge again with inert gas;

Open the circuit by cutting or brazing.

The refrigerant charge shall be recovered into the correct recovery cylinders. The system shall be flushed with OFN to

render the unit safe. This process may need to be repeated several times. Compressed air or oxygen shall not be used for this task.

Flushing shall be achieved by breaking the vacuum in the system with OFN and continuing to fill until the working pressure is achieved, then venting to atmosphere, and finally pulling down to a vacuum. This process shall be repeated until no refrigerant is within the system.

When the final OFN charge is used, the system shall be vented down to atmospheric pressure to enable work to take place. This operation is absolutely vital if brazing operations on the pipe-work are to take place.

Ensure that the outlet for the vacuum pump is not close to any ignition sources and there is ventilation available.

### **13. Charging procedures**

In addition to conventional charging procedures, the following requirements shall be followed. Ensure that contamination of different refrigerants does not occur when using charging equipment. Hoses or lines shall be as short as possible to minimise the amount of refrigerant contained in them.

Cylinders shall be kept upright.

Ensure that the refrigeration system is earthed prior to charging the system with refrigerant.

Label the system when charging is complete (if not already).

Extreme care shall be taken not to overfill the refrigeration system.

Prior to recharging the system it shall be pressure tested with OFN. The system shall be leak tested on completion of charging but prior to commissioning. A follow up leak test shall be carried out prior to leaving the site.

### **14. Decommissioning**

Before carrying out this procedure, it is essential that the technician is completely familiar with the equipment and all its detail. It is recommended good practice that all refrigerants are recovered safely. Prior to the task being carried out, an oil and refrigerant sample shall be taken in case analysis is required prior to re-use of reclaimed refrigerant. It is essential that electrical power is available before the task is commenced.

a) Become familiar with the equipment and its operation.

b) Isolate system electrically.

c) Before attempting the procedure ensure that:

Mechanical handling equipment is available, if required, for handling refrigerant cylinders;

All personal protective equipment is available and being used correctly;

The recovery process is supervised at all times by a competent person;

Recovery equipment and cylinders conform to the appropriate standards.

d) Pump down refrigerant system, if possible.

e) If a vacuum is not possible, make a manifold so that refrigerant can be removed from various parts of the system.

f) Make sure that cylinder is situated on the scales before recovery takes place.

g) Start the recovery machine and operate in accordance with manufacturer's instructions.

h) Do not overfill cylinders. (No more than 80 % volume liquid charge).

i) Do not exceed the maximum working pressure of the cylinder, even temporarily.

j) When the cylinders have been filled correctly and the process completed, make sure that the cylinders and the equipment are removed from site promptly and all isolation valves on the equipment are closed off.

k) Recovered refrigerant shall not be charged into another refrigeration system unless it has been cleaned and checked.

### **15. Labelling**

Equipment shall be labelled stating that it has been de-commissioned and emptied of refrigerant. The label shall be dated and signed. Ensure that there are labels on the equipment stating the equipment contains flammable refrigerant.

### **16. Recovery**

When removing refrigerant from a system, either for servicing or decommissioning, it is recommended good practice that all refrigerants are removed safely. When transferring refrigerant into cylinders, ensure that only appropriate refrigerant recovery cylinders are employed. Ensure that the correct number of cylinders for holding the total system charge is available. All cylinders to be used are designated for the recovered refrigerant and labelled for that refrigerant (i.e. special cylinders for the recovery of refrigerant). Cylinders shall be complete with pressure relief valve and associated shut-off valves in good working order. Empty recovery cylinders are evacuated and, if possible, cooled before recovery occurs.

The recovery equipment shall be in good working order with a set of instructions concerning the equipment that is at hand and shall be suitable for the recovery of flammable refrigerants. In addition, a set of calibrated weighing scales shall be available and in good working order. Hoses shall be complete with leak-free disconnect couplings and in good condition. Before using the recovery machine, check that it is in satisfactory working order, has been properly maintained and that any associated electrical components are sealed to prevent ignition in the event of a refrigerant release. Consult manufacturer if in doubt.

The recovered refrigerant shall be returned to the refrigerant supplier in the correct recovery cylinder, and the relevant Waste Transfer Note arranged. Do not mix refrigerants in recovery units and especially not in cylinders. If compressors or compressor oils are to be removed, ensure that they have been evacuated to an acceptable level to make certain that flammable refrigerant does not remain within the lubricant. The evacuation process shall be carried out prior to returning the compressor to the suppliers. Only electric heating to the compressor body shall be employed to accelerate this process. When oil is drained from a system, it shall be carried out safely.



When flammable refrigerant are employed, appliance shall be stored in a well-ventilated area where the room size corresponds to the room area as specific for operation. For factory sealed appliances, the nameplate on the unit itself marked the refrigerant charge can be used to calculate  $A_{min}$ .

The required minimum floor area  $A_{min}$  to install an appliance with refrigerant charge  $M(\text{kg})$  shall be in accordance with following:

$$A_{min} = (M / (2,5 \times (LFL)^{(5/4)} \times h_0))^2$$

For R32 frigerant models:

Appliance shall be installed, operated and stored in a room with a floor area larger than  $4 \text{ m}^2$ .

Appliance shall not be installed in an unventilated space, if that space is smaller than  $4 \text{ m}^2$ .

## Operating temperature

When your air conditioner is used outside of the following temperature ranges, certain safety protection features may activate and cause the unit to disable.

Cooling operation	Outdoor Temperature	18°C-43°C (64°F-109°F)
	Indoor Temperature	18°C-52°C (64°F-126°F) (For special tropical models)
Heating operation	Outdoor Temperature	17°C-32°C (62°F-90°F)
	Indoor Temperature	-5°C-24°C (23°F-76°F)
	Indoor Temperature	0°C-27°C (32°F-80°F)

To further optimize the performance of your unit, do the following:

- Keep doors and windows closed.
- The capacity of the room air conditioner must fit the room size for efficient and satisfactory operation.
- Do not block air inlets or outlets.
- Regularly inspect and clean air filters.
- If the power supplied to the unit is not plus/minus 10% of the specified rating, the unit may not function and the fuse may blow.
- Noise from the air conditioner will be louder at night than in the daytime. This is because the noise in the surroundings is comparatively low at night. If your feel that the noise is too loud, switch the thermostat to lower numbers.

## UNIT PARTS IDENTIFICATION

NOTE: Different models have different front panels and cabinets. Illustrations in this manual are for explanatory purposes. The actual shape of your indoor unit may be slightly different. The actual shape shall prevail. See the following figures for references:

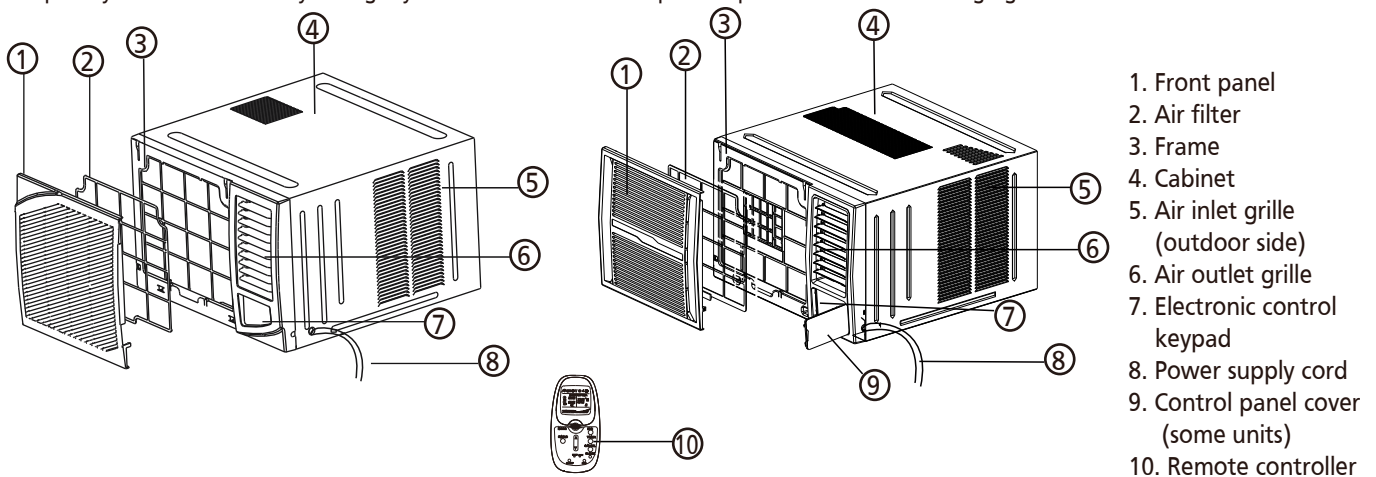

### Accessories

Seal(※)  
(Used on  
drain joint)



1 pc

Drain Joint(※)



1 pc

Drain pan(※)

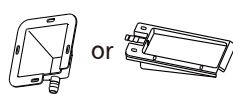

1 pc

Rubber Plug



1~2 pc  
(depending on  
models)

Screw



2 pcs(For some units,  
used to fasten the front  
panel) 2 pcs or 4 pcs(used  
to install the drain pan)

Wooden screw  
(optional)(※)

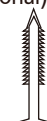

8 pcs  
(depend on  
model you  
purchased)

PVC sheath and  
cable ties(※)



1 pc

4 pcs

[※] Model dependent

## Vent Control

The vent control is located above the control knobs. The operation method and the shape may vary in different models (see the following figures)

For maximum cooling efficiency, CLOSE the vent. It will allow internal air circulation. OPEN the vent to discharge stale air.

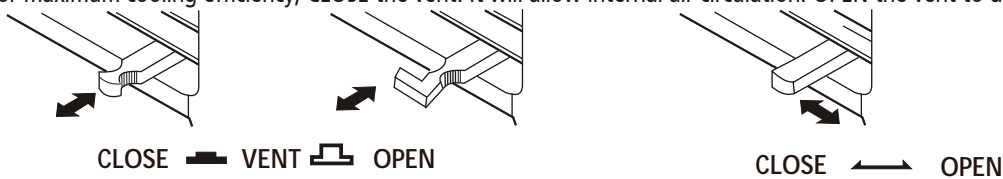

**NOTE:** The vent control is not available for all the units. Some units do not have vent control.

## OPERATING INSTRUCTIONS

**NOTE:** Different models have different operation panels. Not all the functions describing below are available for the air conditioner you purchased. Please check the operation panel of the unit you purchased. The following graphics are for explanatory purposes. The actual shape shall prevail.

**NOTE:** Some models without MED fan speed feature and (or) AUTO mode feature and (or) swing feature.

### POWER:

Press the POWER keypad to turn the unit on/off.

### MODE:

Press the "MODE" keypad to select the appropriate operating mode. The mode selection will alternate between AUTO, HEAT (cooling only models without), COOL, FAN and DRY. The indicator light beside the "MODE" option will illuminate, identifying the mode selected.

### DRY MODE:(on some models)

This mode is used to decrease the humidity in the room. Under this mode, you cannot select a fan speed. The fan motor operates at LOW speed. Keep windows and doors closed for the best dehumidifying effect.

**NOTE:** On the DRY mode, you can not adjust temperature on some models.

### COOL MODE:

The temperature setting are adjustable between 17°C/16°C to 30°C/31°C. You can select your desired fan speed.

### HEAT MODE:(on some models)

The temperature settings are adjustable between 17°C/16°C to 30°C/31°C in heating mode. You can select your desired fan speed.

### AUTO MODE:(on some models)

The fan motor remains on MED speed in AUTO mode. The unit will select the appropriate operating mode from FAN, COOL or HEAT (For reverse cycle models only) based upon the temperature difference between the actual and desired room temperature. Some models without MED speed, the fan motor operates on HIGH speed in AUTO mode.

**NOTE:** On the AUTO mode, you can not adjust temperature and fan speed.

### FAN MODE:(on some models)

Press the "MODE" keypad to select the FAN mode, you can press "FAN" keypad to select your desired fan speed but you can not adjust temperature.

### ▲ TEMPERATURE SETTINGS UP:

Press the ▲ keypad to increase the set (operating) temperature of the unit. Each time the keypad is pressed the temperature increases as follows:

1°C (Celsius Scale) Maximum Setting 30°C/31°C.

### ▼ TEMPERATURE SETTINGS DOWN:

Press the ▼ keypad to decrease the set (operating) temperature of the unit. Each time the keypad is pressed the temperature decreases as follows:

1°C (Celsius Scale) Minimum Setting 17°C/16°C.

### FAN:

Press this keypad to activate the appropriate fan speed setting. Each depression of the keypad will alternate through LOW, MED (on some models), HIGH fan speed options. The indicator light beside the FAN speed option will illuminate, identifying the fan speed selected.

### SWING:(on some models)

Press the "SWING" keypad to activate the automatic air swing feature. The indicator light adjacent to the "SWING" keypad will illuminate, identifying to the selected mode is operational. The vertical louvers will oscillate back and forth (side to side) automatically sweeping air alternately for comfortable cooling/heating. To stop the air swing feature, press the "SWING" keypad again, the indicator light adjacent to the keypad will go off.

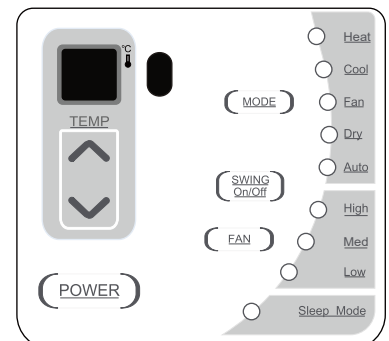
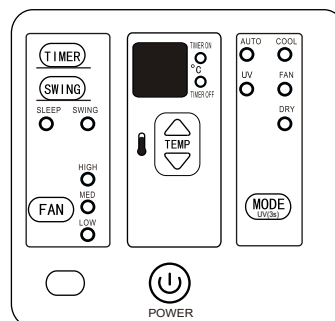
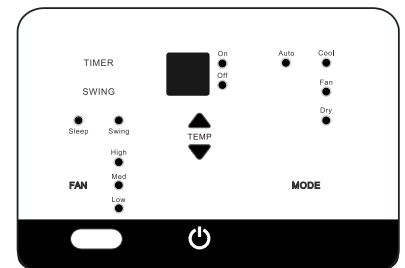
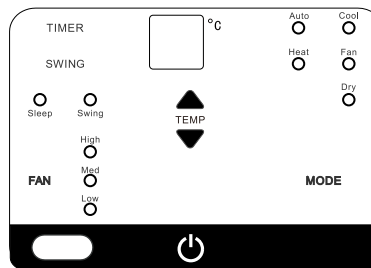
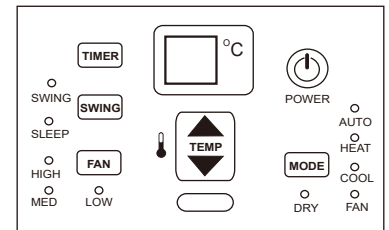
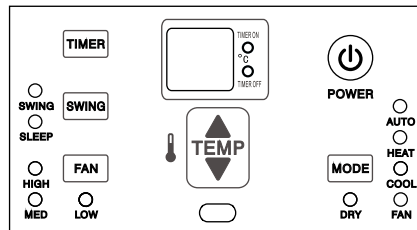
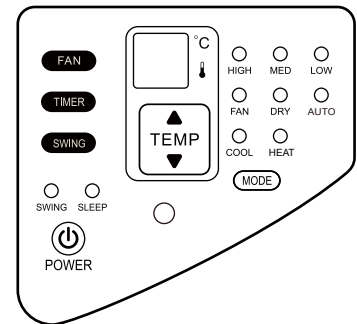
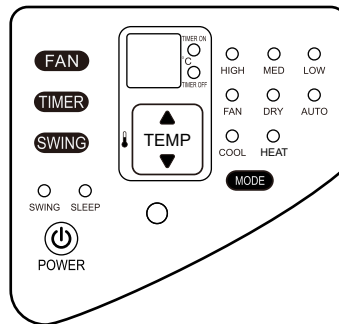

### TIMER:(on some models)

- When the unit is on, press the Timer button will initiate the Auto stop program, the TIMER OFF indicator light illuminates. Press the UP or down button to select the desired time. Press the TI MER button again within 10 seconds, the Auto start program is initiated. And the TI MER ON indicator light illuminates. Press the up or down button to select the desired Auto start time.
- When the unit is off, press the Timer button to initiate the Auto start program, press it again within 10 seconds will initiate the Auto stop program.
- Press or hold the UP or DOWN button to change the Auto time by 0.5 hour increments, up to 10 hours, then at 1 hour increments up to 24 hours. The control will count down the time remaining until start.
- The system will automatically revert back to display the previous temperature setting if there is no operation in a 10 seconds period.
- Turning the unit ON or OFF at any time or adjusting the timer setting to 0.0 will cancel the Auto Start/Stop timer program.

### TIMER:(on some models)

Press the "TIMER" keypad to activate the "auto start/auto stop" timer function.

Auto start/stop programs can be set from 0-12 hours. Each depression of the "TIMER" keypad will increase the selected time in 1 hour increments.

### SLEEP:

Press and hold the "SWING" keypad for 2 seconds or use the remote control to activate the "SLEEP" feature . Press and hold the "SWING" keypad for 2 seconds or use the remote control again to deactivate the "SLEEP" feature. In the Cooling mode, the cooling temperature set point will increase 1 C per hour after the "SLEEP" mode is selected. Two hours later, the set point will continue at this temperature and the fan motor will remain on LOW speed. In the Heating mode, the heating temperature set point will decrease 1 C per hour after the "SLEEP" mode is selected. Two hours later, the set point will continue at this temperature and the fan motor will remain on LOW speed. For Inverter Type the new temperature will be maintained for 7 hours, then the unit exits sleep mode and is off. Using the "SLEEP" mode will reduce noise creating a comfortable sleeping environment.

**NOTE:** This feature is not available under DRY and FAN ONLY operation.

### Turbo function(on some models)

Press the TURBO button by remote controller on COOL/HEAT (For models adopts Electrical heater only) mode, the air conditioner goes into powerful cooling/heating operation. Press again to cancel the TURBO function.

### UV function(on some models)

Press the MODE button for 3 seconds to initiate UV (UltraViolet) feature and the UV light illuminates, the LED DISPLAY shows 'On' for 3 seconds for some units. The UV feature will help to purify the air inside. Press it for 3 seconds again to stop the UV feature and the UV light turn dark, the LED DISPLAY shows 'OF' for 3 seconds for some units.

### LED Display:

- Displays room temperature on fan only mode, displays the setting temperature on the other modes.
- Displays times during Timer setting, after 10 seconds, the system will revert back to display the setting temperature.

### Shows Error codes:(Inverter Type)

E0: Indoor EEPROM error;

E1: Indoor & outdoor communication error;

E3: Indoor fan motor speed out of control;

E4: Room temperature sensor error;

E5: Evaporator temperature sensor error;

EC: Refrigerant leakage detection;

F0: Current overload protection;

F1: Outdoor temperature sensor error;

F2: Condenser temperature sensor error;

F3: Exhaust temperature sensor error;

F4: Outdoor electric EE error;

P0: IPM module error;

P1: Voltage too high/too low protection;

P2: Protection of IPM high temperature;

P3: Protection of outdoor temperature too low

(For the Cooling & Heating models);

P4: Protection of compressor location;

P7: Outdoor IGBT sensor error.

Note: When one of the above malfunctions occurs, turn off the unit, and check for any obstructions. Restart the unit, if the malfunction is still present, turn off the unit and unplug the power cord. Contact the manufacturer or its service agents or a similar qualified person for service.

### Shows Error codes:(Fixed-speed Type)

E<sub>r</sub> Indicates a malfunction of the indoor room temperature sensor

E<sub>v</sub> Indicates a malfunction of the evaporator temperature sensor

E<sub>o</sub> Indicates a malfunction of the outdoor condenser temperature sensor

Note: When one of the above malfunctions occurs, turn off the unit, and check for any obstructions.

Restart the unit, if the malfunction is still present, turn off the unit and unplug the power cord.

Contact the manufacturer or its service agents or a similar qualified person for service.

E<sub>f</sub> Indicates frosting protection (Turn off the unit and restart it to return to normal operation).

E<sub>t</sub> Indicates the requirement of a filter check after 720 hours of fan operation. Turn off the unit, disconnect/unplug from the power supply. Clean the filter, then restore the power, the unit will return to normal operation. This is a reminder to clean the Air Filter for more efficient operation. In the event of a power failure, the "E1" program is automatically re-set. Therefore we suggest you remove and clean the filter before restarting the unit after any power failure. (On some models)

## Operation panel cover (some units)

### For the units with operation panel cover (see the left figures of A & B)

1. Grasp the top or the left of the operation cover and pull it to open it.
2. Close the operation cover and press the cover again until it snaps into the locked position.

DO NOT press or swing the opened operation cover.

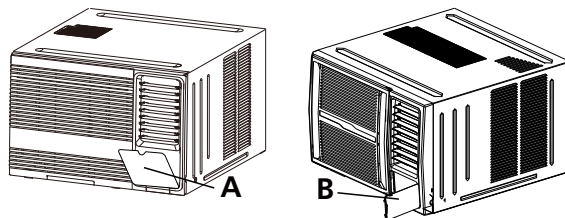

## Air direction control

### Horizontal airflow adjustment

#### For the units with manual control lever(Manually)

To adjust horizontal airflow direction, move the lever gently to the left or right by hand until the desired horizontal airflow direction is obtained (see Fig.C).

### Vertical airflow adjustment(Manually)

When the unit is operating, use the hand to adjust the louvers to change the vertical airflow direction. The vertical angle of air flow can be set by gripping the louver and move to the desired position (see Fig.D).

For some units, the connecting rod of the louver is provided with a convex block, it can be moved between the three grooves on the left side of frame at an angle of 0-15 degrees(see Fig.E).

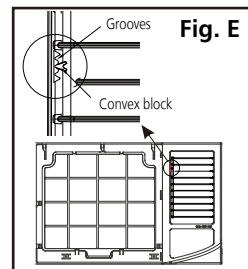
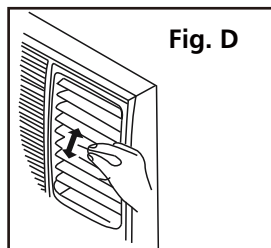
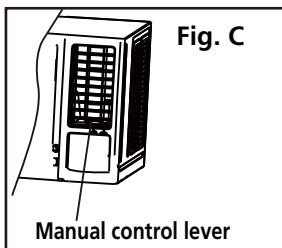

## CARE AND MAINTENANCE

### ⚠ BEFORE CLEANING OR MAINTENANCE

**ALWAYS TURN OFF YOUR AIR CONDITIONER SYSTEM AND DISCONNECT ITS POWER SUPPLY BEFORE CLEANING OR MAINTENANCE.**

### Cleaning Your Unit

### ⚠ IMPORTANT

The cabinet and front panel may be dusted with an oil-free cloth or washed with a cloth dampened in a solution of warm water and mild liquid dishwashing detergent. Rinse thoroughly and wipe dry.

- **Do not** use inflammable sprays such as lacquer or hair spray near the air conditioner
- **Do not** use benzene, alcohol, gasoline, acid, paint thinner, polishing powder or other solvents to clean the unit. The unit can be damaged.
- **Do not** use water hotter than 50°C (122°F) to clean the front panel. This can cause the panel to deform or become discolored.
- Excess water in or around the controls may cause damage to the air conditioner. Be sure to wring excess water from the cloth before wipe it clean.

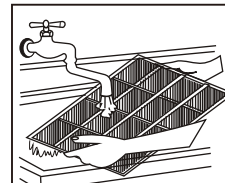
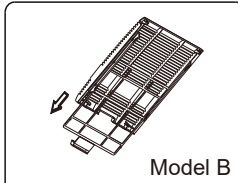
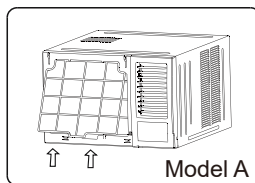
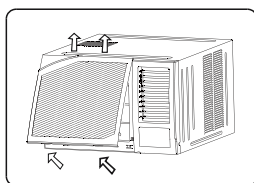

### Cleaning Your Air Filter

A clogged air filter can reduce the cooling efficiency of your unit and increase operating noise. Make sure to clean the filter once every two weeks (or as necessary) during periods of frequent operation.

1. Hold the slot under the front panel, then uplift it outwards, and remove the front panel.
2. Pinch the handle under the air filter and make the air filter arched, remove it from the slot from underside to upside (Model A). Grasp the handle of the filter, then slide it downwards to remove the filter (Model B).
3. Clean the filter with warm, soapy water. The water should be below 40°C (104°F) to prevent distortion of the filter.
4. If your filter has a small air freshening filter, clean this air freshening filter with a hand-held vacuum.
5. Rinse the air filter with fresh water, then shake off excess water.
6. Dry it in a cool, dry place, and refrain from exposing it to direct sunlight.

If your filter has a small air freshening filter (optional), it can be installed at any of the four positions, install it at the position as you like. Clean it with a hand-held vacuum.

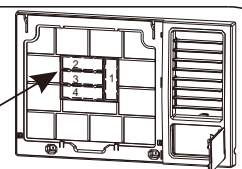

### ⚠ CAUTION

**NEVER** operate the air conditioner without the air filter, as dust/dirt particles can contribute to equipment failure.

### Winter Storage

If you plan to store the air conditioner during the winter, remove it carefully from the window according to the installation instructions. Cover it with plastic or return it to the original carton.

## WATER DRAINAGE

The condensed water can be treated as follows:

**Bottom drainage** (Applicable for the units designed with bottom drain hole only.)

- Remove the rubber plug from the bottom of cabinet (if any)
- Take out the drain pan and screws from accessory.
- Fix the drain pan onto the bottom of cabinet by screws.
- Connect an extension drain hose (locally purchased) to the outlet of drain tray.

**NOTE:** The bottom drainage will slightly affect cooling performance, but it can reduce the noise caused by spraying the condensed water. For pump heating, the bottom drainage must be choosed.

**Back drainage**

- Fit the seal onto the drain joint (provided as accessory).
- Insert the drain joint to the back drainage hole, and rotate it by 90° to be well fitted.
- Connect an extension drain hose (locally purchased according to the installation length request) to the drain joint.
- Make sure to plug the bottom drain hole by rubble plug.

**NOTE:** The back drainage will slightly affect cooling performance, but will reduce the noise caused by spraying the condensed water.

### Non-drainage

If you choose non-drainage when cooling, both the bottom and the back drain holes of the unit should be plugged with rubber plugs. The condensed water will be sprayed to condenser, and will improve the cooling performance.

**NOTE:** When you choose non-drainage, the air conditioner will be perfect cooling efficiency, but big noise may be caused by spraying the condensed water. Please do not choose it if you are sensitive to the noise.

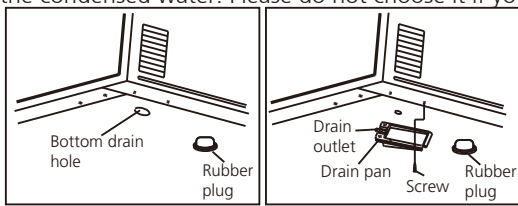

Bottom drainage

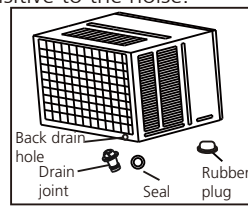

Back drainage

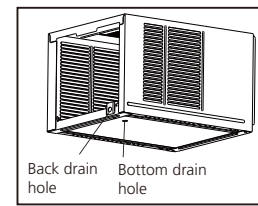

Non-drainage

## Note on the product

- The rated cooling performance is tested under non-drainage status.
- Make sure that water will not leak from the surrounding area when rubber plug and joint were used. Please seal it in case leakage is found.

# INSTALLATION INSTRUCTIONS

## Prior to installation

**CAUTION:** Before installing, remove all packaging from inside the carton, along with any inserts placed into the side louvers.

### Step 1: Select the best location

1. To avoid vibration and noise, make sure the unit is installed securely and firmly.
2. Install the unit where the sunlight does not shine directly on the unit. If the unit receives direct sunlight, build an awning to shade the cabinet.
3. There should be no obstacle, such as a fence or wall, within 50cm from the back of the cabinet because it will prevent heat radiation of the condenser. Restriction of outside air will greatly reduce the cooling and heating efficiency of the air conditioner.
4. Install the unit a little obliquely downward to outside not to leak the condensed water into the room (about 5~7mm).
5. Install the unit with its bottom portion 75~150cm above the floor level.
6. The power cord must be connected to an independent circuit. The yellow/green wire must be grounded.

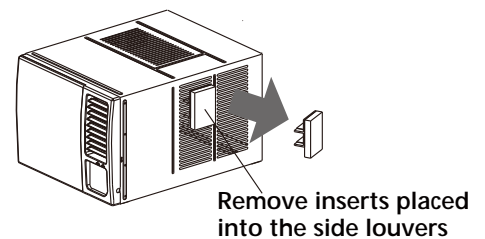

Remove inserts placed into the side louvers

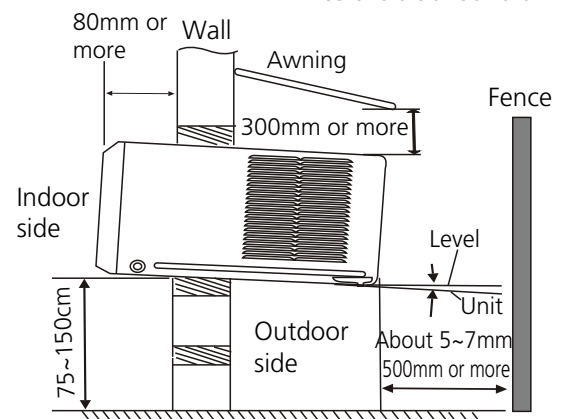

## CAUTION

All side louvers of the cabinet must remain exposed to the outside of the structure.

Option A

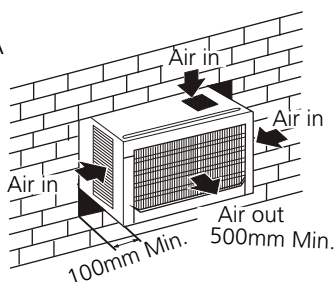

Option B

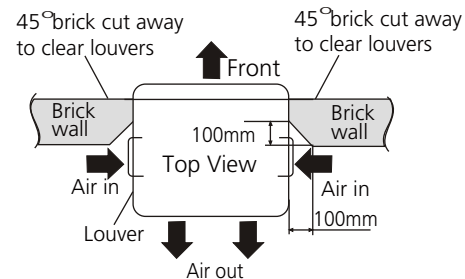

### Step 2: Remove the front panel and air filter

1. Take out the air conditioner from its packaging.
2. Hold the slot under the front panel, then uplift it outwards, and remove the front panel (See Fig. 1)
3. Grip the tab on the end of the filter, lift it up, then pull it towards yourself, pull the filter out (see Fig. 2)

### Step 3: Remove the frame

1. Remove two screws at the bottom of the frame. (See Fig. 3)
2. Disconnect the coupler plugs and make sure not to interfere with the temperature sensor cable. Hold the left bottom side of the frame, lift it up to unlatch the lower side, remove it toward you (See Fig. 4)

**NOTE:** For some units the front panel and frame do not install on the machine placed at the back of the unit, step 2 and step 3 do not need.

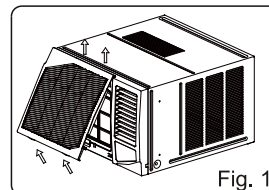

Fig. 1

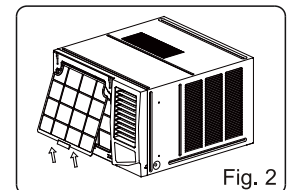

Fig. 2

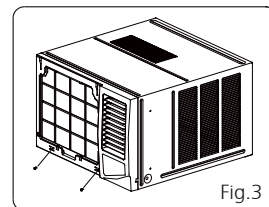

Fig. 3

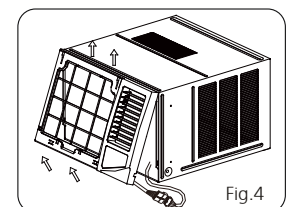

Fig. 4

#### Step 4: Remove the cabinet

**NOTE:** There are slight differences on removing the cabinet according to the different models.

##### Model A:

1. Remove one screw securing the chassis fixing bracket, then take down the chassis fixing bracket as shown in Fig.5A.
2. Grasp the handle on the chassis and carefully slide the air conditioner out of the cabinet.(see Fig.6)

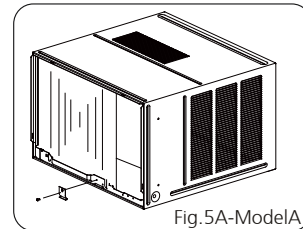

Fig.5A-ModelA

##### Model B:

1. Remove one screw securing the chassis fixing bracket, then take down the chassis fixing bracket. Remove two screws located on the back of the cabinet as shown in Fig.5B.
2. Grasp the handle on the chassis and carefully slide the air conditioner out of the cabinet.(see Fig.6)

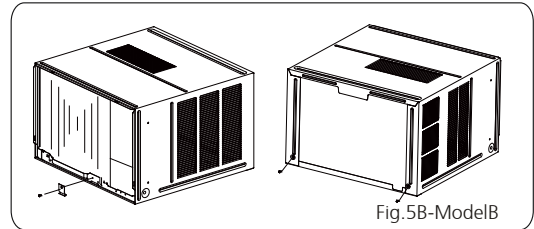

Fig.5B-ModelB

##### Model C:

1. Remove four screws located on both sides and the back of the cabinet as shown in Fig.5C.
2. Grasp the handle on the chassis and carefully slide the air conditioner out of the cabinet.(see Fig.6)

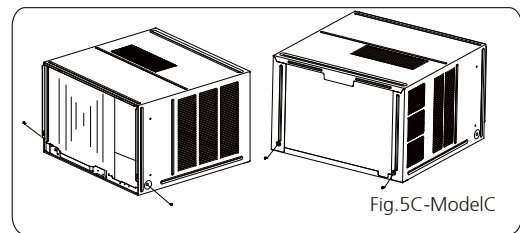

Fig.5C-ModelC

##### Model D:

1. Remove one screw securing the chassis fixing bracket, then take down the chassis fixing bracket.(see Fig.5D)
2. Remove four screws located on both sides and the back of the cabinet as shown in Fig.5D.
3. Grasp the handle on the chassis and carefully slide the air conditioner out of the cabinet.(see Fig.6)

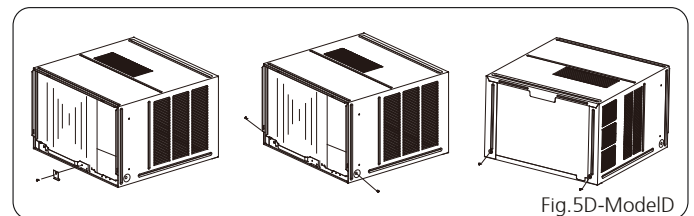

Fig.5D-ModelD

#### Step 5: Install the cabinet

**NOTE:** Unit may be supported by a solid frame from below or by a hanger from a solid overhead support(not supplied, purchase separately, please contact the dealer).

1. When need to drain off water, install the drain plug on the chassis board.
2. Prepare the hole in the wall so that the bottom of the cabinet is well supported, the top has minimum clearance and the air inlet louvers have clearance as shown in previous page(Fig. Option A & B). Holes from the outside through to the cavity should be sealed. The cabinet should slop down towards the rear by about 5~7mm to allow water formed during operation to drain.
3. Install the cabinet into the wall and secure. Ensure the foam seals are not damaged. Flash, seal or fill gaps around the inside and outside to provide satisfactory appearance and protection against the weather, insects and rodents. (see Fig.7)

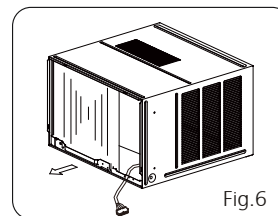

Fig.6

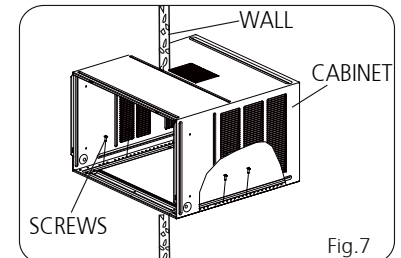

Fig.7

#### Step 6: Install the unit into the cabinet

1. Slide the unit into the cabinet until it is firmly against the rear of the cabinet. Care is required to ensure the foam sealing strips on the cabinet remain in position (See Fig.8).
2. Connect the air conditioner to the power and position excess cord length beneath the air conditioner base.
3. Engage the chassis fixing brackets into the bottom cabinet rail and secure to the base with the screw provided.

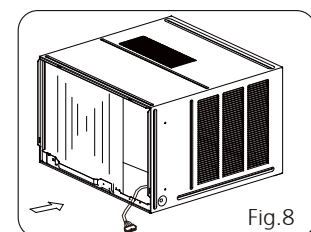
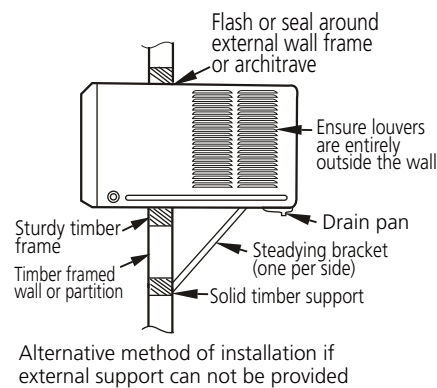
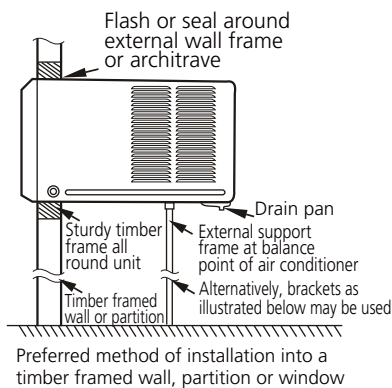

Fig.8

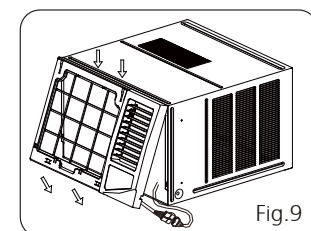

Fig.9

#### Step 7: Install the frame

1. Hook the upper edge of the frame. Then connect the coupler plugs and make sure not to interfere with the temperature sensor cable(see Fig.9).
2. Press the both side and lower edge of the frame, and secure it with the two screws at the bottom of the frame.( See Fig. 10)

**Step 8: Install the air filter and front panel**

1. Insert the air filter into the frame's slot from upside to underside. (See Fig. 2)
2. Hang the front panel on the frame's buckle, then press the front panel into the frame's slot until you hear a click (see Fig.11).
3. Switch unit on. Check for operation of the unit and check for vibration after installation.
4. Fit the drain pan to the cabinet and run a drain hose to a suitable location if required.

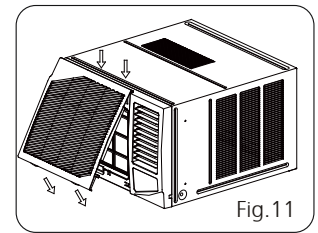
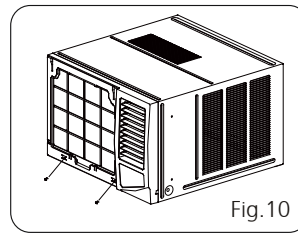

**NOTE: For the unit with power cord comes out from left side,** please perform the following steps:

1. Pull the power cord to the left side straightly(See Fig.a & b).
2. Wrap the PVC protecting sheath on the power cord with cable ties in the hole position (see Fig.c).
3. Tie up the power cord on the frame (see Fig.d & e) (Applicable for units with body dimension of 600mm\*380mm\*560mm only)
4. Install the frame and front panel according to the above Step 6 and Step 7.

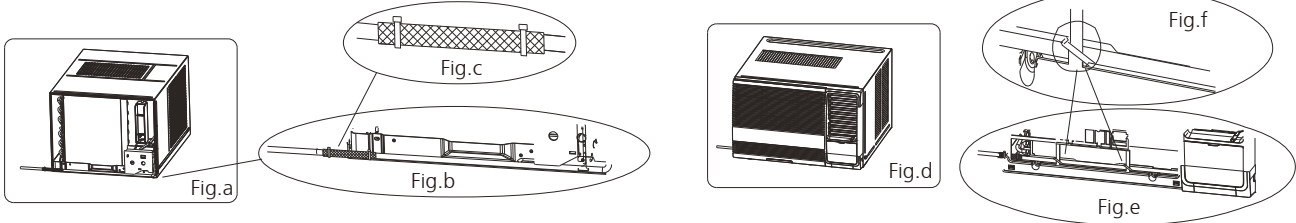

# Troubleshooting



## SAFETY PRECAUTIONS

If ANY of the following conditions occurs, turn off your unit immediately!

- The power cord is damaged or abnormally warm
- You smell a burning odor
- The unit emits loud or abnormal sounds
- A power fuse blows or the circuit breaker frequently trips
- Water or other objects fall into or out of the unit

**DO NOT ATTEMPT TO FIX THESE YOURSELF! CONTACT AN AUTHORIZED SERVICE PROVIDER IMMEDIATELY!**

## Common Issues

The following problems are not a malfunction and in most situations will not require repairs.

Issue	Possible Causes
<b>Unit does not turn on when pressing ON/OFF button</b>	Wall plug disconnected. Push plug firmly into wall outlet.
	House fuse blown or circuit breaker tripped. Replace fuse with time delay type or reset circuit breaker.
	Selector Control in OFF position. Turn selector to the desired FAN or COOL setting.
	Unit turned off by moving thermostat to a higher number and then immediately turning back to a colder number. Wait approximately 3 minutes. Listen for compressor to start.
	Unit turned off and then on too quickly. Turn unit off and wait for 3 minutes before restarting.
<b>Air from unit does not feel cold enough</b>	Thermostat set too low. Adjust thermostat to higher number for cooling.
	Turn selector to a higher COOL position.
	Thermostat set too warm. Set thermostat to colder temperature.
<b>Air conditioner cooling, but room is too warm-ice forming on cooling coil behind decorative front</b>	Room temperature below 18°C(64°F). Cooling may not occur until room temperature rise above 18°C(64°F).
	Temperature sensing tube touching cold coil, located behind air filter. Straighten tube away from coil.
	Outdoor temperature below 18°C(64°F). To defrost the coil, set selector to FAN position. Then, set thermostat to warmer position.
	Air filter may be dirty. Clean filter. Refer to Care and Maintenance section. To defrost, set selector to FAN.
	Thermostat set too cold for night-time cooling. To defrost the coil, set selector to a FAN position. Then, set thermostat to a warmer position.

Issue	Possible Causes
<b>Air conditioner cooling, but room is too warm-ice forming on cooling coil behind decorative front</b>	Dirty air filter- air restricted. Clean air filter. Refer to Care and Maintenance section.
	Thermostat set too warm. Turn thermostat clockwise to a colder setting.
	All directional louvers positioned improperly. Position louvers for better air distribution.
	Front of units is blocked by drapes, blinds, furniture, etc. - restricts air distribution. Clear blockage in front of unit.
	Doors, windows, registers, etc. Open- cold air escapes. Close doors, windows, registers.
	Unit recently turned on in hot room. Allow additional time to remove "Stored heat" from walls, ceiling, floor and furniture.
<b>Air conditioner turns on and off rapidly</b>	Dirty air filter - air restricted. Clean air filter.
	Outside temperature extremely hot. Set to high cool to bring air past cooling coils more frequently.
<b>Noise when unit is cooling</b>	Air movement sound. This is normal. If too loud, turn selector to lower FAN setting.
	Sound of fan hitting water-moisture removal system. This is normal when humidity is high. Close doors, windows and registers.
	Window vibration - poor installation. Refer to installation instructions or check with installer.
<b>Water dripping INSIDE when unit is cooling</b>	Improper installation. Tilt air conditioner slightly to the outside to allow water drainage. Refer to installation instructions - check with installer.
<b>Water dripping OUTSIDE when unit is cooling</b>	Unit removing large quantity of moisture from humid room. This is normal during excessively humid days.

## SPECIFICATIONS

### Unit dimensions:

MODEL(But/h)	BODY DIMENSION(WxHxD)(mm)
5000~6000	445x320x415
	450x346x535
7000~9000	450x346x535
	450x346x585
9000~12000	450x346x585
	560x400x640
	600x380x560
15000~24000	660x428x680
	660x428x780

**Note:** For the different customization requirements, the depth of the panel may be slightly different. So the dimension of "D" is for reference only.

### Choose the right cable size

The size of the power supply cable, signal cable, fuse, and switch needed is determined by the maximum current of the unit. The maximum current is indicated on the nameplate located on the side panel of the unit. Refer to this nameplate to choose the right cable, fuse, or switch.

#### Minimum nominal cross-sectional area of conductors:

Rated Current of Appliance (A)	Nominal Cross-Sectional Area (mm <sup>2</sup> )
> 3 and ≤ 6	0.75
> 6 and ≤ 10	1
> 10 and ≤ 16	1.5
> 16 and ≤ 25	2.5
> 25 and ≤ 32	4
> 32 and ≤ 40	6

The design and specifications are subject to change without prior notice for product improvement. Consult with the sales agency or manufacturer for details. Any updates to the manual will be uploaded to the service website, please check for the latest version.

**CW002UI-F(E)RN8**











A Tradition of leadership and excellence for over 50 years



## **KOPPEL, INC.**

Koppel Head Office:  
106 Industry Drive, Carmelray  
Industrial Park I, Brgy. Canlubang,  
Calamba City, Laguna 4028  
Tel no: (02) 8823-88-83  
Website: [www.koppel.ph](http://www.koppel.ph)

Iloilo Office:  
NSB Bldg., Rizal Street, Iloilo City  
Tel No.: (033) 330-2926  
Cel No.: 0933-867-2907

Cebu Office:  
A. Cortez Avenue, Mandaue City  
Tel No.: (032) 346-7279  
Fax No.: (032) 346-7865

Davao Office:  
J.P. Cabaguio Avenue, Davao City  
Tel Nos.: (082) 221-6419  
Fax No.: (082) 221-6418

Cagayan De Oro Office:  
2nd Floor 28-B, Brgy. Cugman  
Cagayan De Oro City  
Tel Nos.: (088) 880-6326